



Inzetbaarheid:





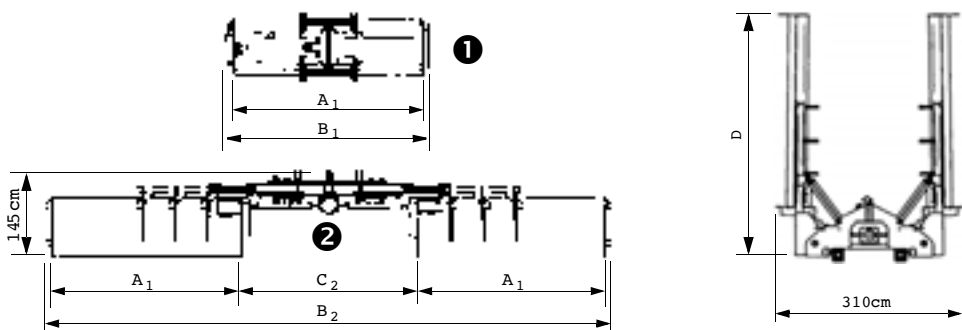

De ideale machine voor grote boerderijen en loonwerkers voor het maaien van gras, stro en maisresten, struikgewas, aardappelloof en braakland.

Standaard uitvoering:

- Tandwielkast met vrijloop, 110 kW (149 Pk) voor de front maaier, 187 kW (254 Pk) voor de achter maaier
- Driepunt aanbouw
- Messen naar keuze
- Stikstofkussen op inklapmechanisme
- Hydraulische verstelling op de voorste maaier
- Hydraulische zekeringen voor transport
- Looprol ø194
- Type 8 aftakas L=1100
- Aandrijving 1.000 tpm
- In hoogte verstelbare glijsoffen



Model	Tandwielkast
	kW (Pk)
READY 800	110 (149) ❶
	187 (254) ❷
READY 920	110 (149) ❶
	187 (254) ❷

Model	Minimaal tractor-vermogen		 max kg	 n°	 n°	 n°	 n°	 n°	 n°	A1	B1	B2	C2	D
	kW	Pk												
READY 800	118	160	1000	964 ❶ 3074 ❷	96 ❶ 192 ❷	64+32 ❶ 128+64 ❷	32 ❶ 64 ❷	32 ❶ 64 ❷	5 ❶ 10 ❷	280	301	827	250	343
READY 920	147	200	1000	1072 ❶ 3350 ❷	96 ❶ 192 ❷	64+32 ❶ 128+64 ❷	32 ❶ 64 ❷	32 ❶ 64 ❷	5 ❶ 10 ❷	320	342	940	280	399